

# trimless spot | long

We aim to create cleaner ceilings.  
Show what you want, hide what you need.

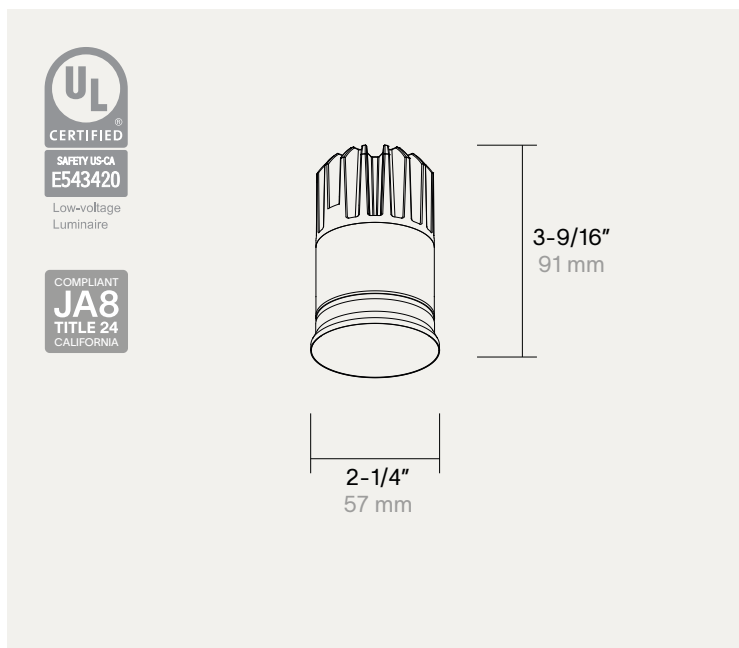

luminaire specs	3
configure yours	4
finishes	5
luminaire output	6
accessories	8
installation rings	9
housing	10
drivers	12

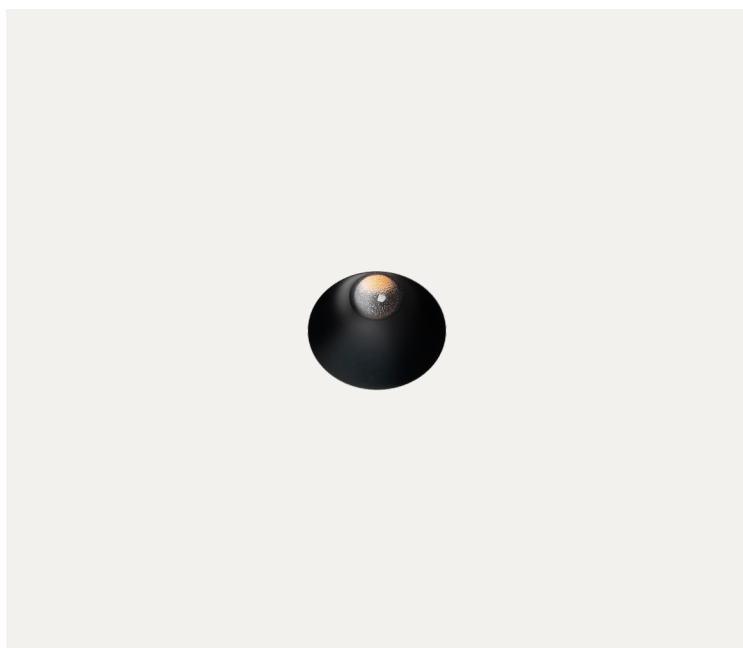

# trimless spot | long

installation

## luminaire specs

delivered lumen	up to 1000lm		
watts	up to 13W		
efficacy	76lm/W		
CRI	90+	97	
R9 value	CRI 90+: >50	CRI 97: >91	
CBCP	25° glass: 3145cd	40° glass: 2073cd	
	60° glass: 1359cd		
color temperature (CCT)	2700K	3000K	3500K
	dim 2 warm: 3000K > 1800K		
color consistency	2-step SDCM		
driver input voltage	120V		
dimming	DALI/0-10V/phase dimming		
power supply	constant current driver with +.9 power factor and +80% efficiency		
optics	25° / 40° / 60°		
suitable for	damp locations (IP44)		
ceiling appearance	trimless		
panel thickness	no panel thickness limitations		
L80	>55000 h		

installation rings (not incl.)	mud ring Ø2-1/4" (Ø57 mm)	<a href="#">↗</a>
	adj. mud ring Ø2-1/4" (Ø57 mm)	<a href="#">↗</a>
housing (not incl.)	IC box airtight	IC box non-airtight
	non-IC frame	remodeling box
material	aluminum	brass
aluminum finishes	black ano	white struc
	brushed steel	brushed grey
	brushed bronze	
aluminum weight	0.59 lb (0.27 kg)	
brass finishes	brushed nickel	light bronze
	dark bronze	canon de fusil dark
	canon de fusil light	
brass weight	0.91 lb (0.41 kg)	
general listings	UL Listed	California Title 24
	warranty	1 year (5 years on LED)

Respect distances, cable sections and IP ratings. Split AC and DC to prevent LED glowing.

configure yours

21011 · -- · --- · --- · ---

product	variant	CRI	CCT *	beam	dimming **	finish
21011. trimless spot	01. long	1 90+	01. 2700K	04 25° glass	0. driver excluded	001 black ano
			02. 3000K	07 40° glass		002 white struc
			03. 3500K	10 60° glass		003 brushed steel
						004 brushed grey
						005 brushed bronze
		90. dim 2 warm		07 40° glass	0. driver excluded	001 black ano
						002 white struc
						003 brushed steel
						004 brushed grey
						005 brushed bronze
	2 97		01. 2700K	04 25° glass	0. driver excluded	001 black ano
			02. 3000K	07 40° glass		002 white struc
			03. 3500K	10 60° glass		003 brushed steel
						004 brushed grey
						005 brushed bronze
					701 brushed nickel	
					702 light bronze	
					703 dark bronze	
					704 canon de fusil dark	
					705 canon de fusil light	

\* other CCT available on request

\*\* phase dimming, 0-10V & dali possible, consult driver matrix, driver sold separately

driver matrix

finishes

aluminum

white struc (RAL 9003)



brushed steel



brushed bronze



brushed grey



black ano



custom brass

brushed nickel



light bronze



dark bronze



canon de fusil light



canon de fusil dark



Custom RAL and brass finishes available on request.

correlated color temperature (CCT)

2700K: extra warm white



3000K: warm white



3500K: neutral white

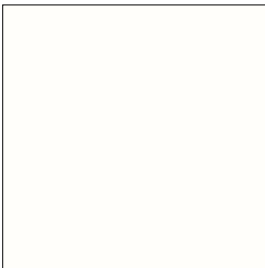

dim 2 warm: 3000K > 1800K

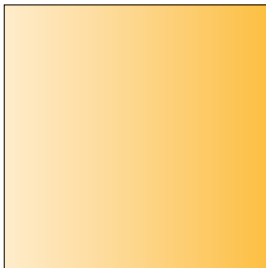

## beam angle

	25° glass	40° glass	60° glass	dim 2 warm (40° glass)
long alu	700mA max	700mA max	700mA max	350mA max
long brass	700mA max	700mA max	700mA max	350mA max

## luminaire output

		350mA	500mA	700mA
		(6.0W, 17.1Vf)	(8.9W, 17.8Vf)	(13.0W, 18.6Vf)
2700K	25° glass	375lm	550lm	725lm
	40° glass	500lm	700lm	950lm
	60° glass	500lm	675lm	925lm
3000K	25° glass	400lm	575lm	750lm
	40° glass	525lm	725lm	975lm
	60° glass	525lm	700lm	950lm
3500K	25° glass	425lm	600lm	800lm
	40° glass	550lm	750lm	1000lm
	60° glass	550lm	725lm	975lm
dim 2 warm	40° glass	525lm	-	-

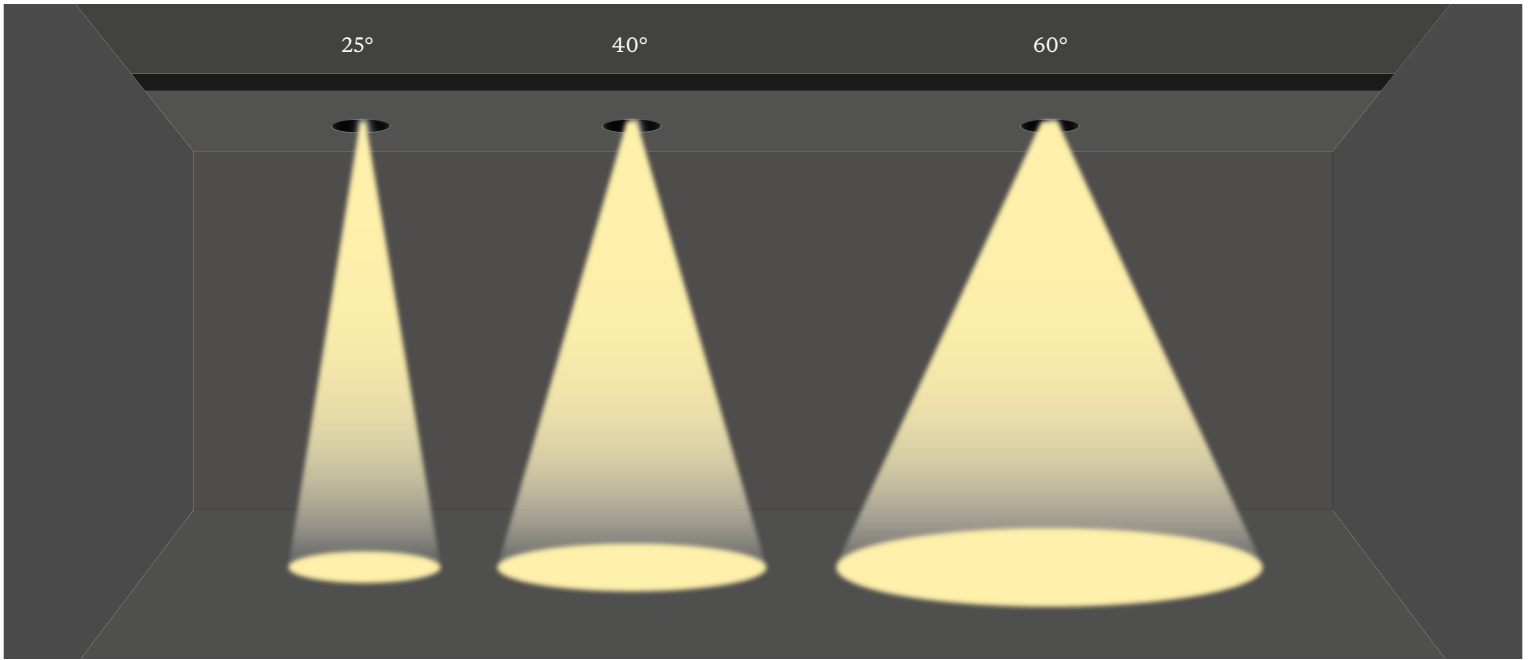

25° glass

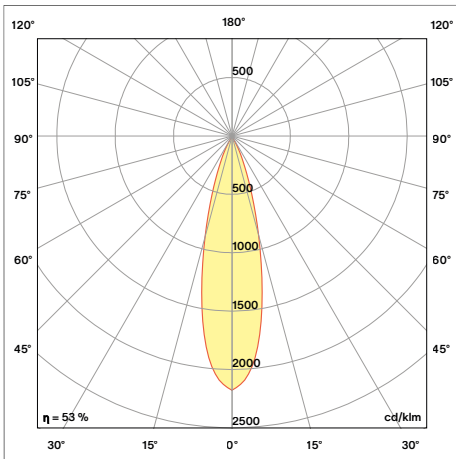

40° glass

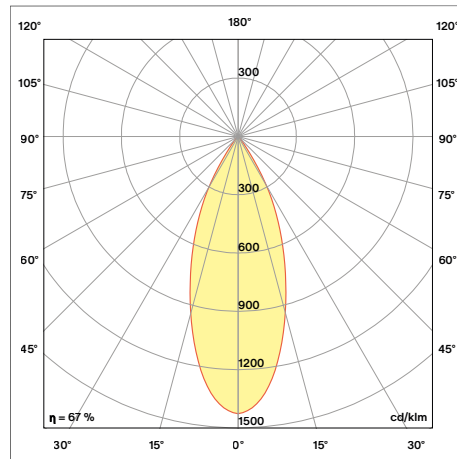

60° glass

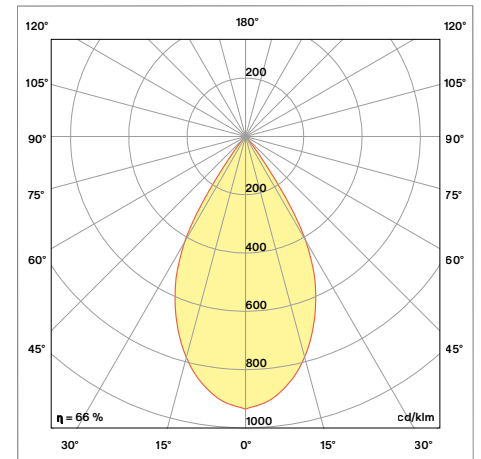

dim 2 warm (40° glass)

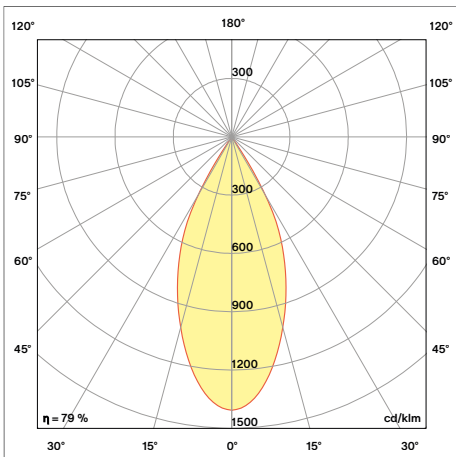

## accessories

## trimless installation rings (not incl.)

	UL listed	product code
mud ring Ø2-1/4" (Ø57 mm)	yes	9001-0003
adj. mud ring Ø2-1/4" (Ø57 mm)	yes	9001-0123

## housing (not incl.)

	UL listed	product code
IC box + plaster frame 3-1/2" high airtight	yes	9000-0107
IC box + plaster frame 3-1/2" high non-airtight	yes	9000-0101
NON-IC plaster frame	yes	9000-0106
remodeling box 2.37×1.5×8	yes	9000-0104
bar hanger kit	n/a	9000-0102

## drivers (not incl.)

	number of fixtures	Title 24 JA8 compliant	UL listed	product code
SOLOdrive 0-10V 350mA 22W	1-2	yes	yes	9000-1008
SOLOdrive 0-10V 500mA 22W	1-2	yes	yes	9000-1002
SOLOdrive 0-10V 700mA 22W	1-2	yes	yes	9000-1009
SOLOdrive DALI 350mA 22W	1-2	yes	yes	9000-1006
SOLOdrive DALI 500mA 22W	1-2	yes	yes	9000-1001
SOLOdrive DALI 700mA 22W	1-2	yes	yes	9000-1007
Phase dimming / 0-10V dimmable driver constant current 350mA 15W	1	yes	yes	9000-1028
Phase dimming / 0-10V dimmable driver constant current 500mA 15W	1	yes	yes	9000-1029
Phase dimming / 0-10V dimmable driver constant current 700mA 15W	1	yes	yes	9000-1030
DALI / 0-10V dimmable driver 60W constant current multi power	2-4	no	yes	9000-1014

trimless installation rings (not incl.)

	product code	application	drill hole
mud ring Ø2-1/4" (Ø57 mm)	9001-0003	plastered ceiling	Ø2-2/3" (Ø68 mm)
adj. mud ring Ø2-1/4" (Ø57 mm)	9001-0123	plastered ceiling	Ø3" (Ø76 mm)

plastered ceiling

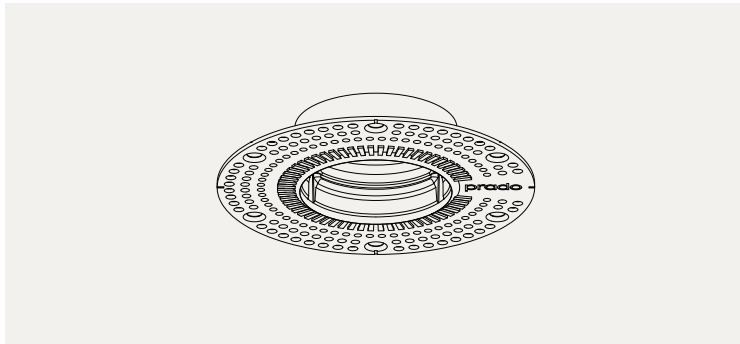

**mud ring Ø2-1/4" (Ø57 mm)**

[spec sheet](#)

location	ceiling indoor
plaster thickness	1/7" (3.6 mm)
drill hole	Ø2-2/3" (Ø68 mm)

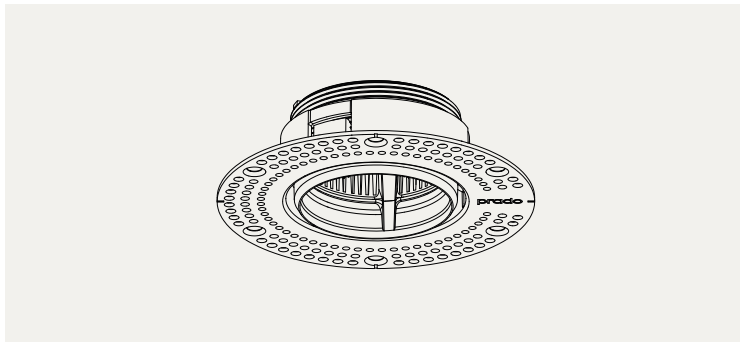

**adj. mud ring Ø2-1/4" (Ø57 mm)**

[spec sheet](#)

location	ceiling indoor
plaster thickness	min. 1/7" (3.6 mm)    max. 3/4" (20 mm)
drill hole	Ø3" (Ø76 mm)

## housing (not incl.)

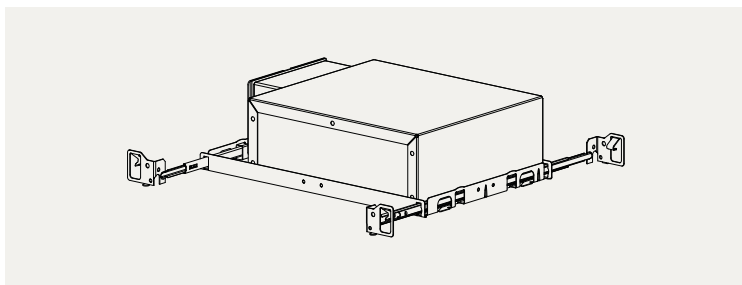
**IC box + plaster frame 3-1/2" high**[spec sheet](#)

new construction airtight / non-airtight

for use insulated ceiling

UL listed

dimensions D x W x H 12-7/16 × 8-9/16 × 3-7/16"

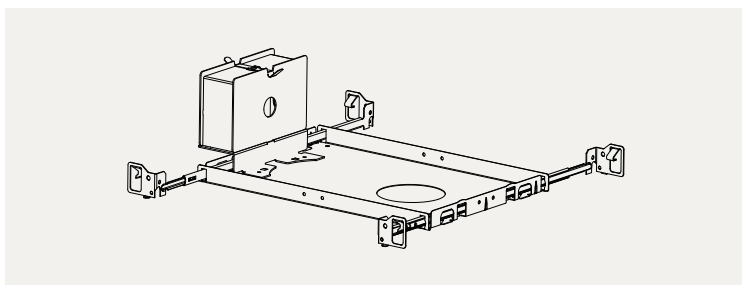
**non-IC plaster frame**[spec sheet](#)

new construction

for use in non-insulated ceiling

UL listed

dimensions D x W x H 15 × 8-9/16 × 4-3/8"

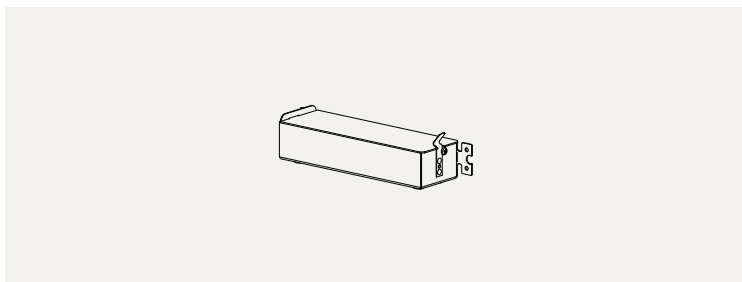
**remodeling box 2.37x1.5x8**[spec sheet](#)

for remote installation

UL listed

does not fit through hole

dimensions D x W x H 8 × 2-9/16 × 1-2/3"

illustration trimless installation rings in combination with IC boxes

mud ring Ø2-1/4" (Ø57 mm)

installation

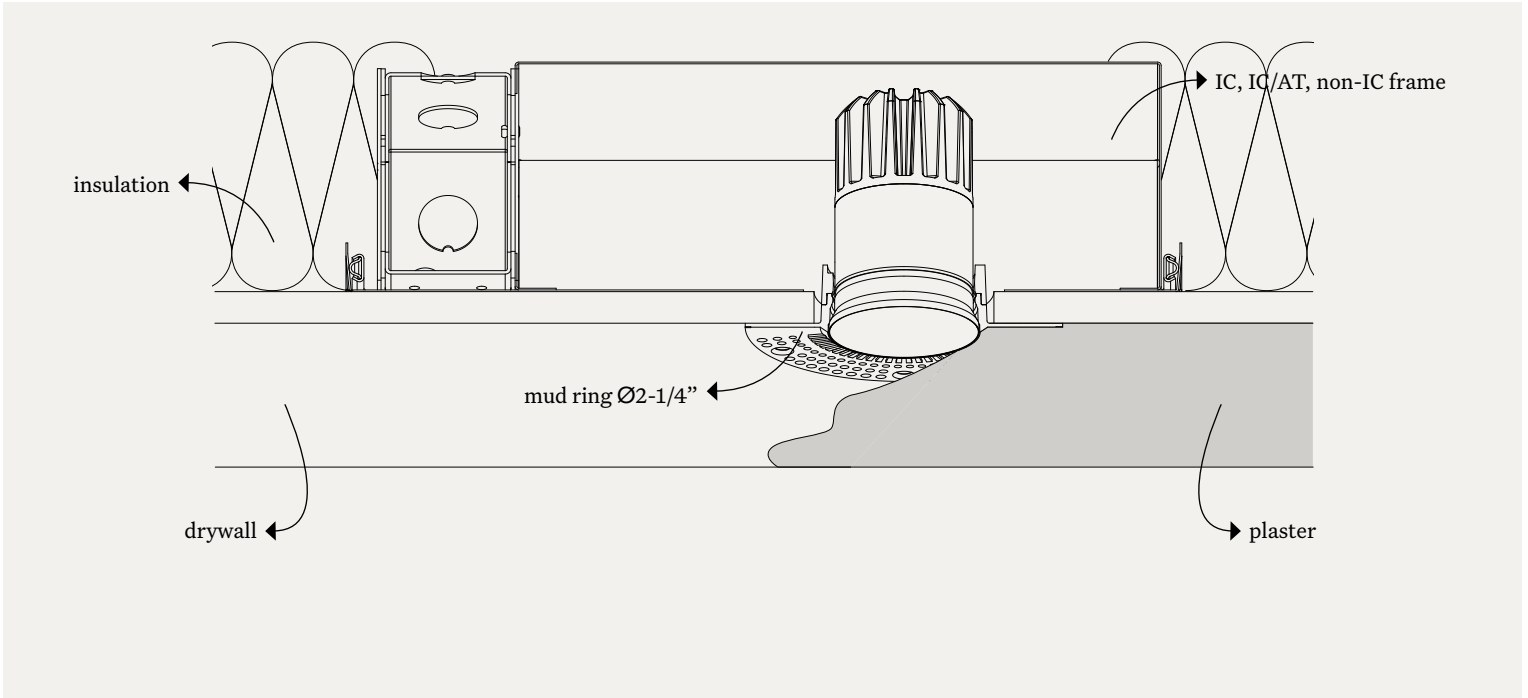

adj. mud ring Ø2-1/4" (Ø57 mm)

installation

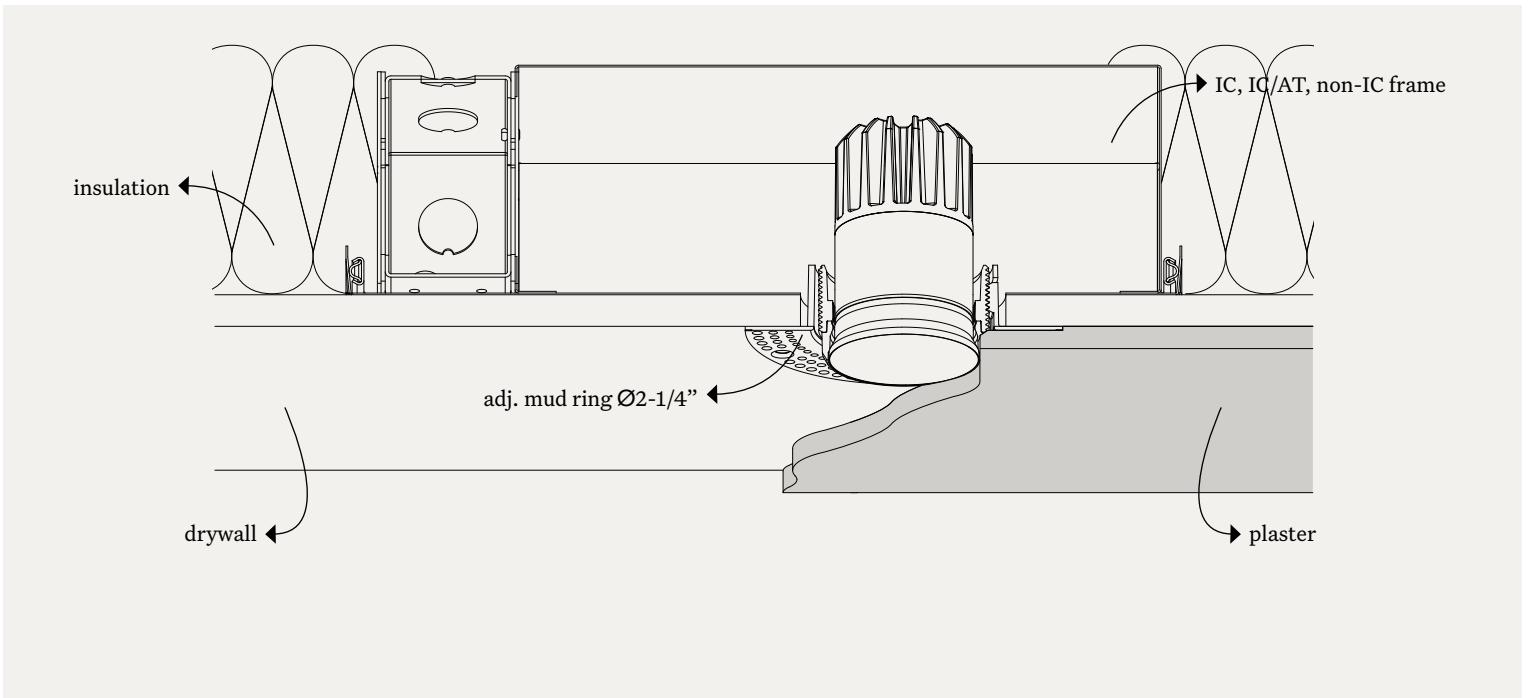

**driver matrix**

new construction	insulated ceiling	IC box + plaster frame 3-1/2"	remote driver	remodeling box 2.37x1.5x8
			local driver	driver in inner junction box
	non-insulated ceiling	non-IC plaster frame	remote driver	remodeling box 2.37x1.5x8
			local driver	driver in inner junction box
remodeling			remote driver	remodeling box 2.37x1.5x8

driver matrix

cable length

**compatible drivers**

**remodeling box 2.37x1.5x8 / integral driver box**

SOLOdrive 0-10V 350mA 22W

SOLOdrive 0-10V 500mA 22W

SOLOdrive 0-10V 700mA 22W

SOLOdrive DALI 350mA 22W

SOLOdrive DALI 500mA 22W

SOLOdrive DALI 700mA 22W

Phase dimming / 0-10V dimmable driver constant current 350mA 15W

Phase dimming / 0-10V dimmable driver constant current 500mA 15W

Phase dimming / 0-10V dimmable driver constant current 700mA 15W

illustration driver matrix

local driver

above ceiling access required for both installation and service <sup>1</sup>

check driver matrix (cut-out column) <sup>2</sup>

<sup>2</sup> remodel

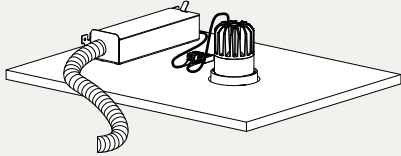

driver matrix

<sup>1</sup> new construction  
non-IC

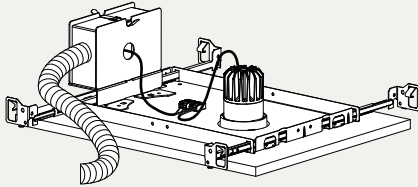

<sup>1</sup> new construction  
IC 3-1/2"

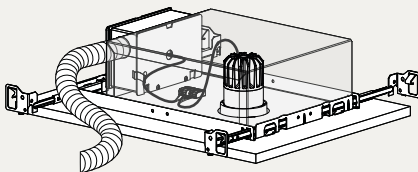

remote driver <sup>3</sup>

remodel

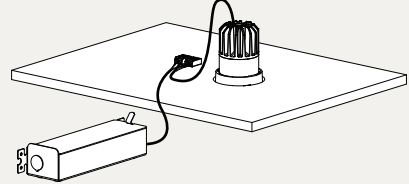

new construction  
non-IC

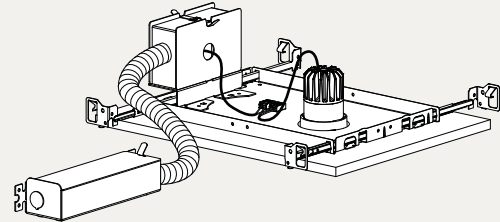

new construction  
IC 3-1/2"

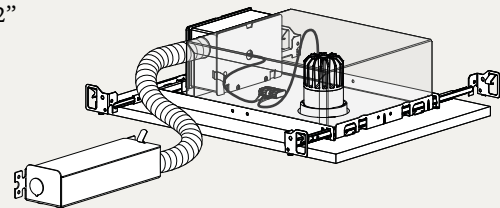

**\*\* max driver distance**

AWG18 (2 × 1 mm<sup>2</sup>) 40 ft (12 m)

AWG16 (2 × 1.5 mm<sup>2</sup>) 65 ft (20 m)

AWG14 (2 × 2.5 mm<sup>2</sup>) 100 ft (30 m)

AWG12 (2 × 4 mm<sup>2</sup>) 160 ft (49 m)

wiring diagram

serial connection

